



Products

MODULES

ZION
Communication



Zion Communication
Structured Cabling & Data Center



STRUCTURE CABLING MODULES

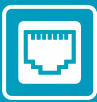

Telecommunication Module & Accessories

Contact of disconnection module



Contact of connection module

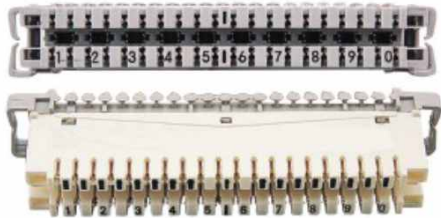

ZC-1001AB

10 Pairs Connection & Disconnection Module

- A: 10 Pairs Connection Module
- B: 10 Pairs Disconnection Module
- Plastic material: ABS or PBT
- Contact Material: Iron, Brass or Bronze

ZC-1001C

10 Pairs Connection & Disconnection Module (Profile Type)

- C-1: 10 Pairs Connection
- C-2: 10 Pairs Disconnection
- Plastic Material: ABS or PBT

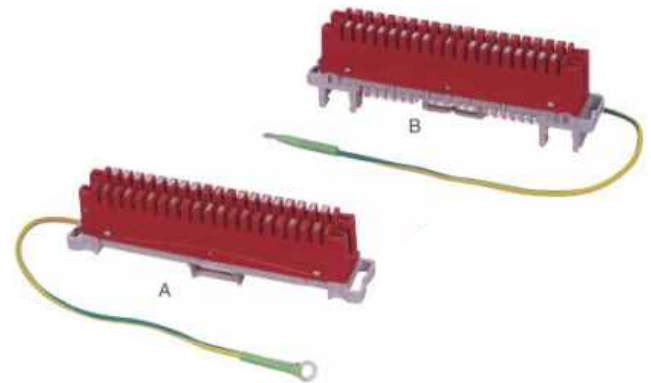

ZC-1001D

10 pair cat.5e profile highband disconnection module

ZC-1001E

8 Pairs LSA Disconnection Module

- Plastic Material: ABS or PBT

ZC-1002

10 Pairs Earth Module

- A: 10 Pairs Earth Module
- B: 10 Pairs Earth Module (Profile Type)

- Plastic material: PBT
- normally 50cm wire length



Telecommunication Module & Accessories

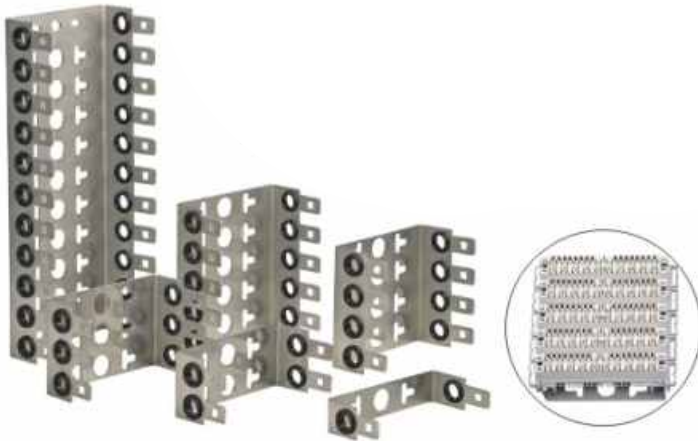

ZC-1302

Stainless steel back mount frame
•With Rubber Grommet
*1 way to more ways as per customer's request



ZC-130202

11 WAY Back Mount Frame
Material: 304 Stainless Steel
Height: 30mm



ZC-2109B

1 Pair Disconnection Plug
• To open 1 pair Contact of Disconnection Module



ZC-1307

Single Pair Lighting Protector Unit
With 3P Arrester
(DC Spark-over Voltage:230V)



ZC-1067

Arrester Magazine For 10 Pair
A: With 3 Pole Arrester
B: With 2 Pole Arrester



Telecommunication Module & Accessories



ZC-1069B

110 Plug
• Cat.6 4 Pairs Plug



ZC-1069C

110 Plug (Transparent material)
C-1: 1 pair plug
C-2: 2 pairs plug
C-2: 3 pairs plug
C-2: 4 pairs plug

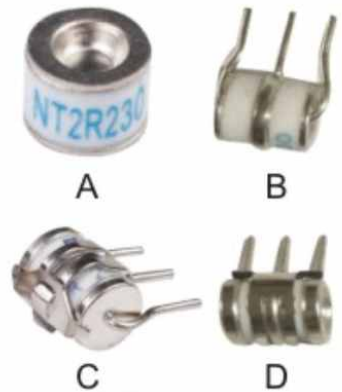

ZC-1099

Gas Discharge Tube
A: 2 Pole Arrester
B: 3 Pole Arrester without fuse
C: 3 Pole Arrester with fuse
D: 3 Pole Arrester with fuse

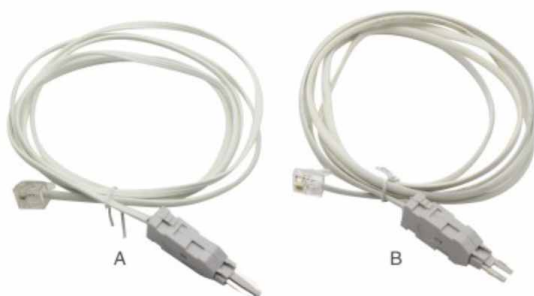

ZC-1308

Test Cord
A: 2 Pole with 6p2c plug
B: 4 Pole with 6p4c plug Length: 1.5m or more

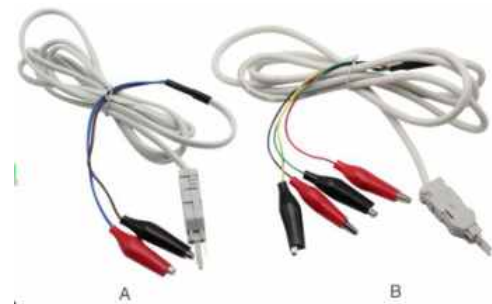

ZC-1309

Test Cord With Alligator Clip
A: 2 Pole Test Cable
B: 4 Pole Test Cable
Length: 1.5m or more



Telecommunication Module & Accessories

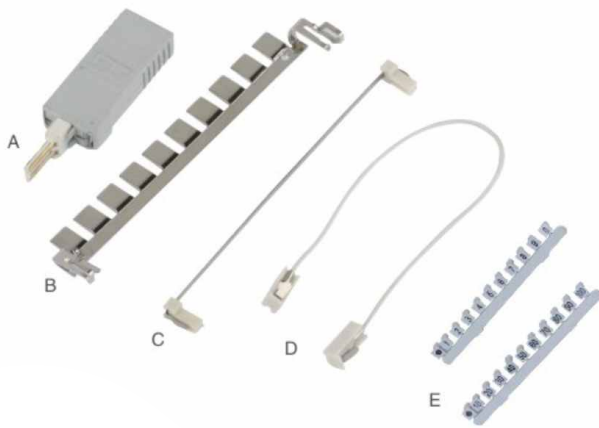

ZC-1310

- A: Lighting Protector Unit With LED light
- B: Earth bar for Grounding When Single Line Protector Is Operating
- C: Alarm Strip
- D: Alarm Wire
- E: Number Flags(Printer 1—0) or (Printer 10-100)



ZC-1366

3M Test Cord for straight splicing module

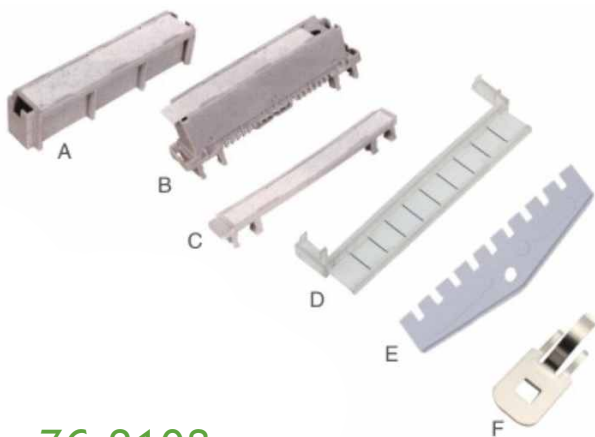

ZC-2108

- A: Label Holder For Mounting Frame
- B: Label Holder For Profile Frame
- C: Low Label Holder for Profile Frame
- D: Transparent label Holder For 10 Pairs Module
- E: Disconnection Plug For 10 Pairs Module
- F: Earthing Line For LSA Profile Module

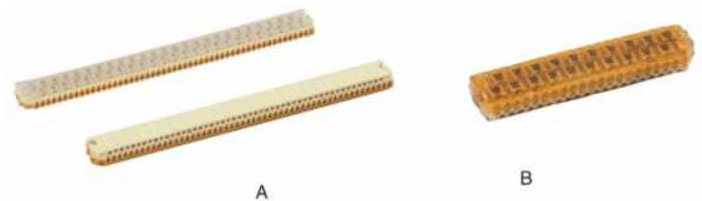

ZC-1038

- Splicing Module**
- A: 25 Pairs Splicing Module
4000-D type(Clear Cover)
- B: 10 Pairs Splicing Module,
with gel or without gel for optional

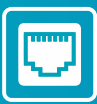

Telecommunication Module & Accessories



ZC-1313

Back Mounting Bracket

- A: 19 inch 100 pairs profile rod
 - B: Stainless steel 150 pairs Mounting Frame for 19" Cabinet
 - C: Stainless steel 150 pairs Mounting Frame for 19" Cabinet
 - D: Stainless steel 100 pairs Mounting Frame for 19" Cabinet
 - E: 90 Pair Mounting Frame for 19" Rack (Paint type)
 - F: 150 Pair Mounting Frame for 19" Rack (Paint type)
 - G: 180 Pair Mounting Frame for 19" Rack (Paint type),
- *Material: Metal or 304 Stainless steel

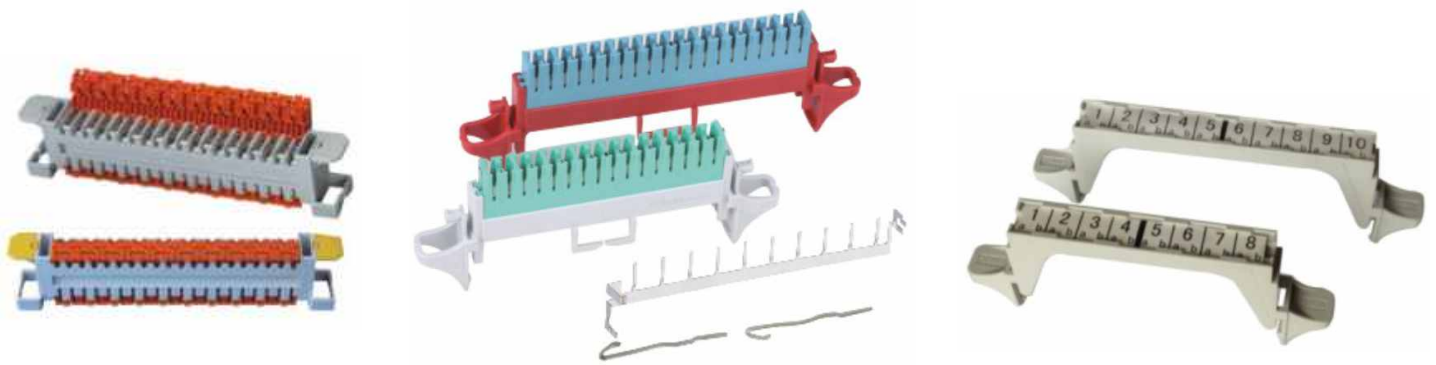
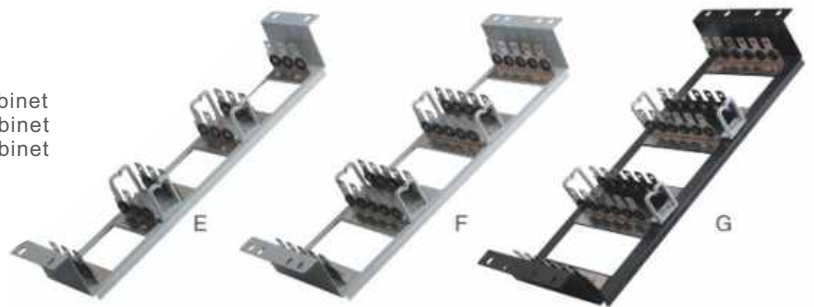

ZC-1320

10 Pair tool-less Connection Module

- *With gel
- *Cat.5e Performance
- *3M 2810 type

ZC-1321

STG Module (Pouyet Type)

- A-1: 8 Pair Disconnection module
- A-2: 8 Pair Connection module
- B-1: 10 Pair Disconnection module
- B-2: 10 Pair Connection module
- C-1: 16 Pair Disconnection module
- C-2: 16 Pair Connection module
- D: 10 Pair STG Module Earthing bar + 2 pins

ZC-1322

STG Module Label Holder

- A: 8 pair STG Module Label Holder
- B: 10 pair STG Module Label Holder

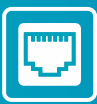

Lock Joint Connectors

ITEM PHOTO	CODE	WIRING	INSULATION	WIRE DIAMETER
	UY		1.52mm	0.4-0.7mm
	UY2		2.08mm	0.4-0.9mm
	UR		1.67	0.4-0.9mm
	UR2		2.08	0.4-0.9mm
	UB		1.27mm	0.4-0.7mm
	UG		1.67mm	0.4-0.9mm
	UDW2		4.4mm	0.9-1.3mm
	B		1.27mm	0.32-0.7mm
	HJKT10		0.055"(1.4mm)	21-26 (0.7-0.4mm)
	HJKT13		0.15"(3.8mm)	22-14AWG (0.5-1.5mm)



ZC-2104

Green striped Picabond splice connector



ZC-2105

Blue striped Picabond splice connector

- Wire Range: 0.12-0.40 mm²(26-22 AWG)
- Insulation Outer Diameter 0.46-1.22 mm
- Package: 1000pcs/Plastic Box or 1000pcs/roll



Keystone Jacks

ZM265-C5/6/6A(ZM245-1)

UTP RJ45 90 degree keystone jack



- Meet ISO/IEC 11801,TIA/EIA568C.
- Own patent products.
- Fit for wires AWG22-26.
- IDC contacts: Maximum 200 reterminations.
- Min. life 750 insertions.
- Material: PC/ABS for cover, PC for module , phosphor bronze for IDC .
- IDC: 45°.

Order Information:

PART Number	Descriptioa
ZM245-C5	Cat5e
ZM245-C6	Cat6
ZM245-C6A	Cat6A



Keystone Jacks

ZM265-C5/6/6A(ZM245-2)

UTP RJ45 90 degree keystone jack

- Meet ISO/IEC 11801, TIA/EIA568C.
- Own patent products.
- Fit for wires AWG22-26.
- IDC contacts: Maximum 200 reterminations.
- Min. life 750 insertions.
- Material: PC/ABS for cover, PC for module , phosphor bronze for IDC.

Order Information:

PART Number	Descriptioa
Z M265-C5	Cat5e
Z M265-C6	Cat6
ZM265-C6A	Cat6A

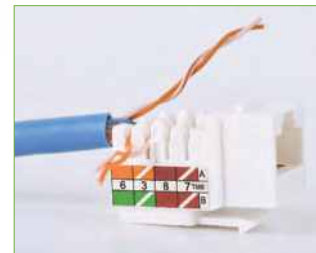

ZM267-C5/6/6A(ZM245-3)

UTP RJ45 90 degree keystone jack

- Meet ISO/IEC 11801, TIA/EIA568C.
- Own patent products.
- Fit for wires AWG22-26.
- IDC contacts: Maximum 200 reterminations.
- Min. life 750 insertions.
- Material: PC/ABS for cover, PC for module , phosphor bronze for IDC.

Order Information:

PART Number	Descriptioa
ZM267-C5	Cat5e
ZM267-C6	Cat6
ZM267-C6A	Cat6A

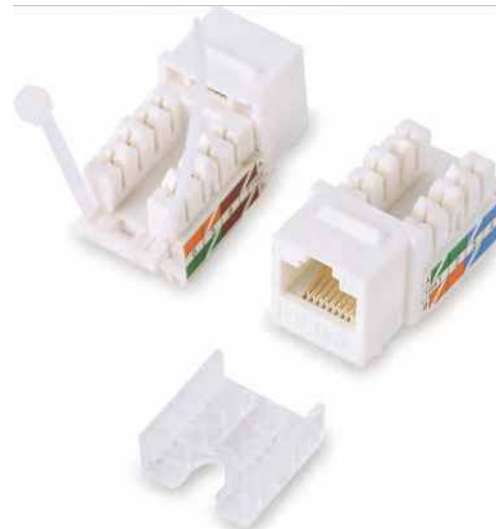



Keystone Jacks

ZM255

UTP RJ45 180 degree keystone jack

- Meet ISO/IEC 11801, TIA/EIA568C.
- Own patent products.
- Fit for wires AWG22-26.
- IDC contacts: Maximum 200 reterminations.
- Min. life 750 insertions.
- Material : PC/ABS for cover, PC for module, phosphor bronze for IDC .
- Cat.5e/6 keystone jack 180°.

Order Information:

PART Number	Descriptioa
Z M255-C5(M255A)	Cat5e
Z M255-C6(M255B)	Cat6

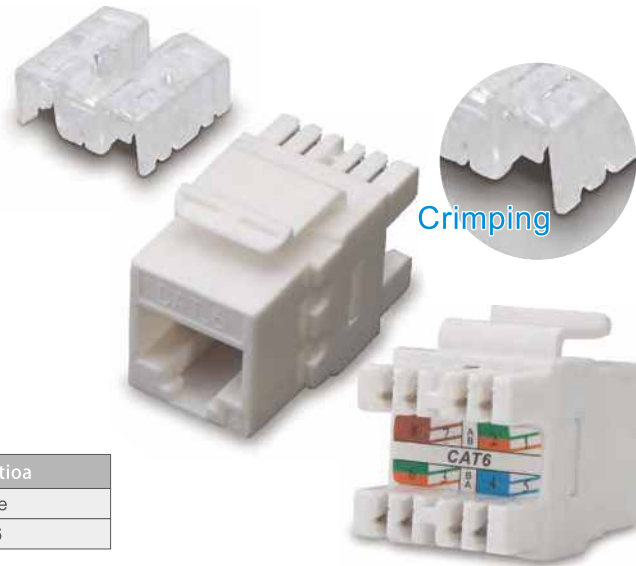

ZM242

Toolless UTP keystone jack

- Meet ISO/IEC 11801, TIA/EIA568C.
- Fit for wires AWG22-26.
- IDC contacts: Maximum 200 reterminations.
- Min. life 750 insertions.
- Material : PC/ABS for cover, PC for module, phosphor bronze for IDC .

Order Information:

PART Number	Descriptioa
Z M242-C5	Cat5e
Z M242-C6	Cat6
Z M242-C6A	Cat6A





Keystone Jacks

ZM262

Toolless keystone jack shielded .



- Meet ISO/IEC 11801, TIA/EIA568C.
- Own patent products.
- Fit for wires AWG22-26.
- IDC contacts: Maximum 200 reterminations.
- Min. life 750 insertions.
- Material: PC/ABS for cover, PC for module , phosphor bronze for IDC .
- 360° Shielding-die cast housing.

Order Information:

PART Number	Descriptioa
ZM262-C5	Cat5e
ZM262-C6	Cat6
ZM262-C6A	Cat6A



Keystone Jacks

ZM221

8P8C Coupler Without Wire

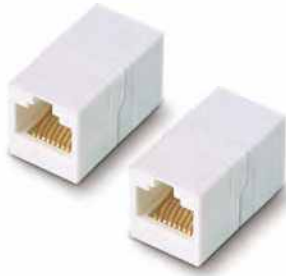

ZM222-C5

UTP CAT5e Coupler



ZM222-C6

UTP CAT6 Coupler



ZM223

UTP CAT5E Coupler



ZM224

UTP CAT6 Coupler



ZM225

UTP Cat.5e keystone jack coupler



ZM226

UTP Cat6 keystone jack coupler



ZM228

FTP Cat6 keystone jack coupler





Keystone Jacks

IDC Clarification for RJ45 Keystone jack



110 IDC



Krone IDC



Dual IDC

• Dual IDC Suitable to Be Punched by both "110" and "Krone" Tool



ZC-1009

A: Cat.5e RJ45 Keystone jack
B: Cat.6 RJ45 Keystone jack
*110 IDC

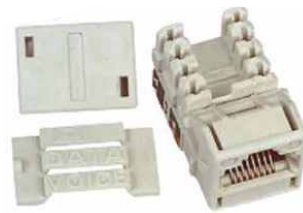

ZC-1010

Cat.5e RJ45 Keystone Jack
* Systemax Type



ZC-1011

Cat.5e RJ45 Keystone Jack
* Tool-less Type



ZC-1013

Cat.5e RJ45 Shielded Keystone Jack,
*110 IDC



ZC-1014

Cat.3 RJ1K6P4C) Keystone Jack
*For Telephone
*110 IDC



ZC-1014B

Cat.3 RJ11 Keystone Jack
* Screw Type



ZC-1014C

Mini Cat.3 RJ11 Keystone jack
*110 IDC



ZC-1014D

Mini Cat.3 RJ11 Keystone jack
Dual IDC
*Suitable for Patch Panel ZN-4021



ZC-1108B

Cat5e RJ45 (8P8C) Keystone Jack
*Tool-less Type
*Panduit type



Keystone Jacks



ZC-1109

A: Cat.5e RJ45 (8P8C) Keystone Jack
B: Cat.6 RJ45 Keystone Jack
*110 IDC



ZC-1110

A: Cat.5e RJ45 180° Keystone Jack
B: Cat.6 RJ45 180° Keystone Jack
* Suitable for Patch Panel GL-4001
* Dual IDC



ZC-1111

A: Cat.6 RJ45 UTP Keystone jack
B: Cat.6 RJ45 STP Keystone jack
* Suitable for Patch Panel GL-4006
*110 IDC



ZC-1113

Cat.3 RJ11 (6P4C) Keystone Jack
*Tool-less Type



ZC-1114

Cat.6 RJ45 Keystone Jack
* Systimax Type



ZC-1117

Cat.3 RJ11 (6P4C) Keystone Jack
* Tool-less Type



ZC-1119

A: Cat.5e RJ45 Keystone Jack
B: Cat.6 RJ45 Keystone Jack
*Dual IDC



ZC-1120

CAT.3 RJ1K6P4C) Keystone Jack
*Dual IDC



ZC-1123

A: Cat.5e RJ45 Keystone Jack
B: Cat.6 RJ45 Keystone Jack
* Dual IDC

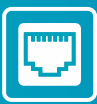

Keystone Jacks



ZC-1125

A: Cat.5e RJ45 Keystone Jack
B: Cat.6 RJ45 Keystone Jack



ZC-1127

Cat.6 RJ45 180° Keystone Jack
* Krone IDC
* Suitable for Patch Panel ZN-PP-3724



ZC-1129

A: Cat.5e RJ45 Shielded Keystone Jack
B: Cat.6 RJ45 Shielded Keystone Jack
* Dual IDC



ZC-1131

Cat.3 RJ11 (6P4C) Keystone Jack
* Tool-less Type



ZC-1133

Cat.6 RJ45 Keystone Jack
* Systemax Type



ZC-1136

Cat.3 RJ11 (6P4C) Keystone Jack
* Tool-less Type



ZC-K056

Tool-less Rotary UTP Keystone Jack
A: Cat.6 B: Cat.6A



ZC-K060

Tool-less UTP Keystone Jack
A: Cat.6 B: Cat.6A



ZC-K033

180 Degree Tool-less Rotary
Cat.6 RJ 45 keystone jack
A: Cat.6 B: Cat.6A C: Cat.5e
* legrand type back , amp type front jack



ZC-1140

A: Cat.5e RJ45 180° Keystone Jack
B: Cat.6 RJ45 180° Keystone Jack
C: Cat.6A RJ45 180° Keystone Jack
* Suitable for Patch Panel ZN-4001
* Dual IDC



ZC-1149

A: Cat.5e RJ45 (8P8C) Keystone Jack
B: Cat.6 RJ45 Keystone Jack
* Dual IDC

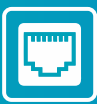

Keystone Jacks



ZC-1124

A: Cat.5e RJ45 Keystone Jack
B: Cat.6 RJ45 Keystone Jack
*With Cable tie
*Dual IDC



ZC-1137

3M Type Tool-less RJ45 Keystone Jack
A: Cat.5e RJ45 Keystone Jack
B: Cat.6 RJ45 Keystone Jack



ZC-K050S

Tool-less STP Keystone Jack
A: Cat.6
B: Cat.6A



ZC-K050

Tool-less UTP Keystone Jack
A: Cat.6
B: Cat.6A



ZC-K055S

Tool-less STP Keystone Jack
A: Cat.6
B: Cat.6A



ZC-K055

Tool-less UTP Keystone Jack
A: Cat.6
B: Cat.6A



ZC-K001

Cat.5e RJ45 Keystone Jack
*Ieviton Type



ZC-K002

Cat.6 180 degree RJ45 Keystone Jack
*Ieviton Type



ZC-K005

French type Shutter
A:Cat.5e B:Cat.6 C: Cat.6A
*Ieviton type
45 x 45mm Single Port Shutter
45 x 45mm Dual Port Shutter



ZC-K006

French type Single port Shutter
Cat.3
22.5 x 45mm Single Port Shutter
*Ieviton type



ZC-K003

French type Single port Shutter with STP Jack
A:Cat.5e B:Cat.6 C:Cat.6A
22.5 x 45mm Single Port Shutter
*Ieviton type



ZC-K004

French type Single port Shutter with UTP Jack
A:Cat.5e B:Cat.6 C: Cat.6A
22.5 x 45mm Single Port Shutter
*Ieviton type

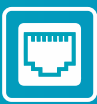

Inline Couplers



ZC-1227

Rj45 Cat.5e Inline Coupler
A: unshielded
B: shielded



ZC-1142

Rj45 Inline Coupler
A:Cat.5e Inline Coupler
B:Cat.6 Inline Coupler
C:Cat.6A Inline Coupler



ZC-1132

Rj45 Inline Coupler
A:Cat.5e Inline Coupler
B:Cat.6 Inline Coupler
C:Cat.3 Inline Coupler
*Black or white color



ZC-1134

Rj45 Inline Coupler
A:Cat.5e Inline Coupler
B:Cat.6 Inline Coupler
* Black or white color



ZC-1135

Rj45 Inline Coupler
A: Cat.5E
B: Cat.6
C: Cat.6A
Black or White



ZC-1143

Rj45 STP Inline Coupler
A: Cat.5E
B: Cat.6
C: Cat.6A



ZC-K007

French type Keystone jack
A: Cat.5e B: Cat.6 C: Cat.6A
*with Black Back base
*45x45mm Single Port

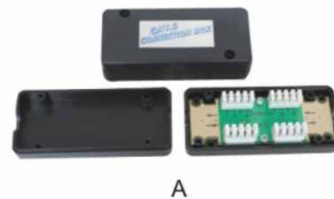

ZC-1139

Cat.6 Connection Box
A: Un-shielded,black color
B: Fully shielded, argentine color
*Krone IDC
*Size: 84x37x23mm

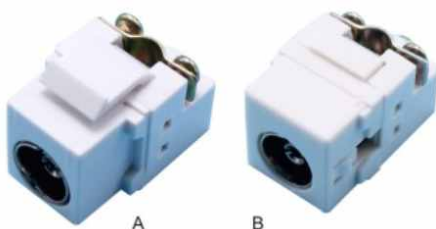
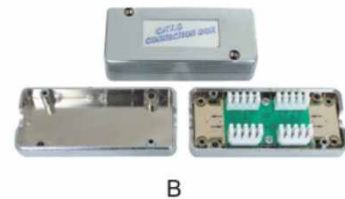

ZC-250

Catv Keytone Jack
A: amp type jack
B: systimax type jack



ZC-CA003

Cat.5E Connection Box
A: Un-shielded,black color
B: Shielded, argentine color
*Krone IDC, with colored table
*Size: 66x36x26mm





Inline Couplers



ZC-1138
Cat.5e Inline coupler
* Size: 48x25x23mm



ZC-CA002
CAT.6 Connection box
Shielded, Argentine color Krone IDC
Size: 68.5x40.5x26mm



ZC-CA0074
ISDN 4 ports Adapter
A: Shielded type
B: Unshielded type
Input: RJ45 Plug
Output: 4 ports RJ45 Socket
Cable length: 150mm



ZC-CA0075
ISDN 5 ports Adapter
A: Shielded type
B: Unshielded type
Input: RJ45 Plug
Output: 5 ports RJ45 Socket
Cable length: 150mm



ZC-CA011
ISDN 1 to 5 ports Adaptor



ZC-6002
Cord Coupler
A: 6P4C
B: 6P6C
C: 8P8C



ZC-6003
Triplex Adaptor
A: 6P4C
B: 6P6C
C: 8P8C



ZC-6004
Modular duplex jack
A: 6P4C
B: 6P6C
C: 8P8C



Surface Box



ZC-6008

Rossette Surface Box

A: 6P4C B: 8P8C

*Size:56x50x21 mm



ZC-6006

Single Surface Box

A:6P6C B:6P4C

*Size:58x42x24mm



ZC-6007

Dual Surface Box

A:6P6C B:6P4C

*Size:58x42x24mm



ZC-1240

Surface Box

A: Single port *size: 26x48x64mm

B: Duple port *size: 26x65x75mm

* Suitable for 1pc or 2pcs RJ45 keystone Jacks



ZC-1241

Rj45 UTP Single Port Surface box

A: Cat.5e B: Cat.6

* Single Port

* Sizeze:25x50x65mm



ZC-1242

Rj45 UTP Dual Ports Surface Box

A: Cat.5e B: Cat.6

* Dual Ports

* Size:27x58.5x60mm



ZC-1046

Surface Box

A: Single Port 26x42x60mm

B: Dual Ports 26x60x70mm

C: 6 Ports 26x60x1 82mm

* Suitable for 1pcs, 2pcs or 6pcs RJ11 or RJ45 Keystone Jack



ZC-1243

Cat.6 RJ45 Surface Box

* Single Port

* Sizeze:25x50x65mm



ZC-1244

Cat.6 RJ45 Surface Box

* Dual Ports

* Size:27x58.5x60mm



Surface Box



ZC-1240

Surface Box

A: Single port *size: 26x48x64mm
 B: Dule port *size: 26x65x75mm
 * Suitable for 1pc or 2pcs RJ45 keystone Jacks



ZC-1241

Rj45 UTP Single Port Surface box

A: Cat.5e
 B: Cat.6
 * Single Port
 * Size:25x50x65mm



ZC-1242

Rj45 UTP Dual Ports Surface Box

A: Cat.5e B: Cat.6
 *Dual Ports
 *Size:27x58.5x60mm



ZC-1046

Surface Box

A: Single Port 26x42x60mm
 B: Dual Ports 26x60x70mm
 C: 6 Ports 26x60x182mm
 * Suitable for 1pcs, 2pcs or 6pcs RJ11 or RJ45 Keystone Jack



ZC-1243

Cat.6 RJ45 Surface Box

* Single Ports
 * Size:25x50x65mm



ZC-1244

Cat.6 RJ45 Surface Box

*Dual Ports
 *Size:27x58.5x60mm



ZC-1245

Rj45 STP Single Port Surface Box

A: Cat.5e B: Cat.6
 *Single Port
 *Size:25x50x65mm
 *Krone IDC



ZC-1246

Rj45 STP Dual Ports Surface Box

A: Cat.5e B: Cat.6
 *Double Ports
 *Size:27x58.5x60mm
 *Krone IDC



ZC-1249

RJ45+RJ11 Surface Box

*Size:27x58.5x60mm
 *Krone IDC



ZC-1247

Cat.6 RJ45 STP Surface Box

*Single Port
 *Size:25x50x65mm
 *Krone IDC



ZC-1248

Cat.6 RJ45 STP Surface Box

*Double Ports
 *Size:27x58.5x60mm
 *Krone IDC



Surface Box



ZC-1245

Rj45 STP Single Port Surface Box

A: Cat.5e B: Cat.6

* Single Port

* Size:25x50x65mm

* Krone IDC .

ZC-1246

Rj45 STP Dual Ports Surface Box

A: Cat.5e B: Cat.6

* Dual Port

* Size: 27x58.5x60mm

* Krone IDC .

ZC-1249

RJ45+RJ11 Surface Box

*Size:27x58.5x60mm

* Krone IDC .



ZC-1247

Cat.6 RJ45 STP Surface Box

* Single port

* Size: 25x50x65mm

* Krone IDC

ZC-1248

Cat.6 RJ45 STP Surface Box

* Dual port

* Size: 27x58.5x60mm

* Krone IDC

● GLOBAL MARKET



For more information
please visit us at:
www.zion-communication.com



■ China - Head office

EMAIL: info@zion-communication.com
TEL: +86 571 63804414
FAX: +86 571 63804424
ADD: NO.68, HuaQiao Road, JinCheng Street, LinAn,
ZheJiang, China 311300